

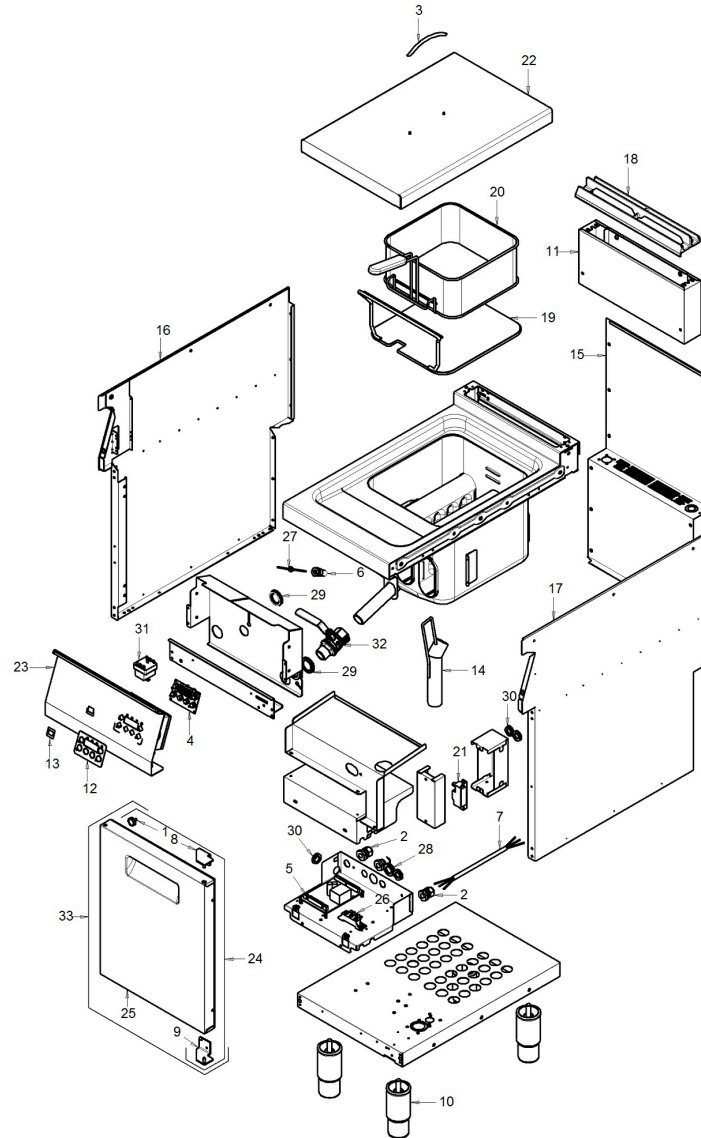



























1
HOME / COTTURA / ICON7000 / OS1FR3GD / 1



1
HOME / COTTURA / ICON7000 / OS1FR3GD / 1

	Modifica	 ↑↓	Codice	↑↓ Descrizione	↑↓ Cons.	Prezzo ↑↓	Qtà Data validità
			1 3020990	MAGNETE	X	8,51	1 06/04/2021-
			2 3059590	PRESSACAPO + GHIERA		4,17	3 06/04/2021-
			3 3104440	MANIGLIA		13,68	1 06/04/2021-24/02/2022
			3 3104441	MANIGLIA		16,46	1 25/02/2022-
			4 3123452	SCHEDA ELETTR. FRIGGITRICE G/E	X	245,74	1 06/04/2021-
			5 3123471	SCHEDA ELETTRONICA	X	420,84	1 06/04/2021-
			6 3146500	RACCORDO Sonda Ø3.5		19,70	1 06/04/2021-
			7 3227680	CAVO ALIM.		21,66	1 06/04/2021-
			8 3253550	CERNIERA SUPERIORE DX		27,73	1 06/04/2021-
			9 3253560	CERNIERA INFERIORE DX		27,73	1 06/04/2021-
			10 3271580	PIEDE INOX COMP.		0,00	4 06/04/2021-28/02/2022
			10 3439700	PIEDE INOX COMP.		14,84	4 01/03/2022-
			11 3278620	MITRA COMP.		131,63	1 06/04/2021-
			12 3289480	PANNELLO COMANDI FR. DIGITALE	X	36,51	1 06/04/2021-
			13 3345650	DISPLAY PILOTA ADESIVO		23,93	1 06/04/2021-
			14 3356320	TUBO SCARICO OLIO	X	78,27	1 06/04/2021-
			15 3361830	RETRO		0,00	1 06/04/2021-
			16 3369300	FIANCO SX		0,00	1 06/04/2021-05/11/2021
			16 3369301	FIANCO SX		242,04	1 06/11/2021-
			17 3369310	FIANCO DX		0,00	1 06/04/2021-05/11/2021

1
HOME / COTTURA / ICON7000 / OS1FR3GD / 1

	Modifica	   Codice	  Descrizione	  Cons.	Prezzo  	Qtà Data validità
		17 3369311	FIANCO DX		247,81	1 06/11/2021-
		18 3384120	MASCHERINA SCAR.FUMI-400 V.2	X	49,70	1 06/04/2021-
		19 3412770	FONDO P/CESTELLI		94,37	1 06/04/2021-
		20 3412780	CESTELLO FRIGG.GAS		105,85	1 06/04/2021-
		21 3413270	ACCENDITORE 2U 230V	X	23,67	1 06/04/2021-
		22 3420410	COPERCHIO VASCA		106,83	1 06/04/2021-
		24 6045171	GR.CERNIERA PORTA DX	X	42,27	1 06/04/2021-
		25 6054570	GR. PORTA DX	X	284,74	1 06/04/2021-
		26 32D0171	MORSETTIERA PR.TERRA	X	6,64	1 06/04/2021-
		27 32V5750	TERMORESISTENZ PT1000	X	76,10	1 06/04/2021-
		28 32X0120	PASSACAVO	X	1,75	1 06/04/2021-
		29 32X0130	PASSACAVO Ø29-Ø44		2,49	2 06/04/2021-
		30 32X0140	PASSACAVO	X	1,85	4 06/04/2021-
		31 32Z5612	TERMOSTATO SICUREZZA	X	87,14	1 06/04/2021-
		32 33D1980	VALVOLA SFERA MF 1"	X	57,31	1 06/04/2021-
		33 M070610	MODULO PORTA DX		0,00	1 06/04/2021-



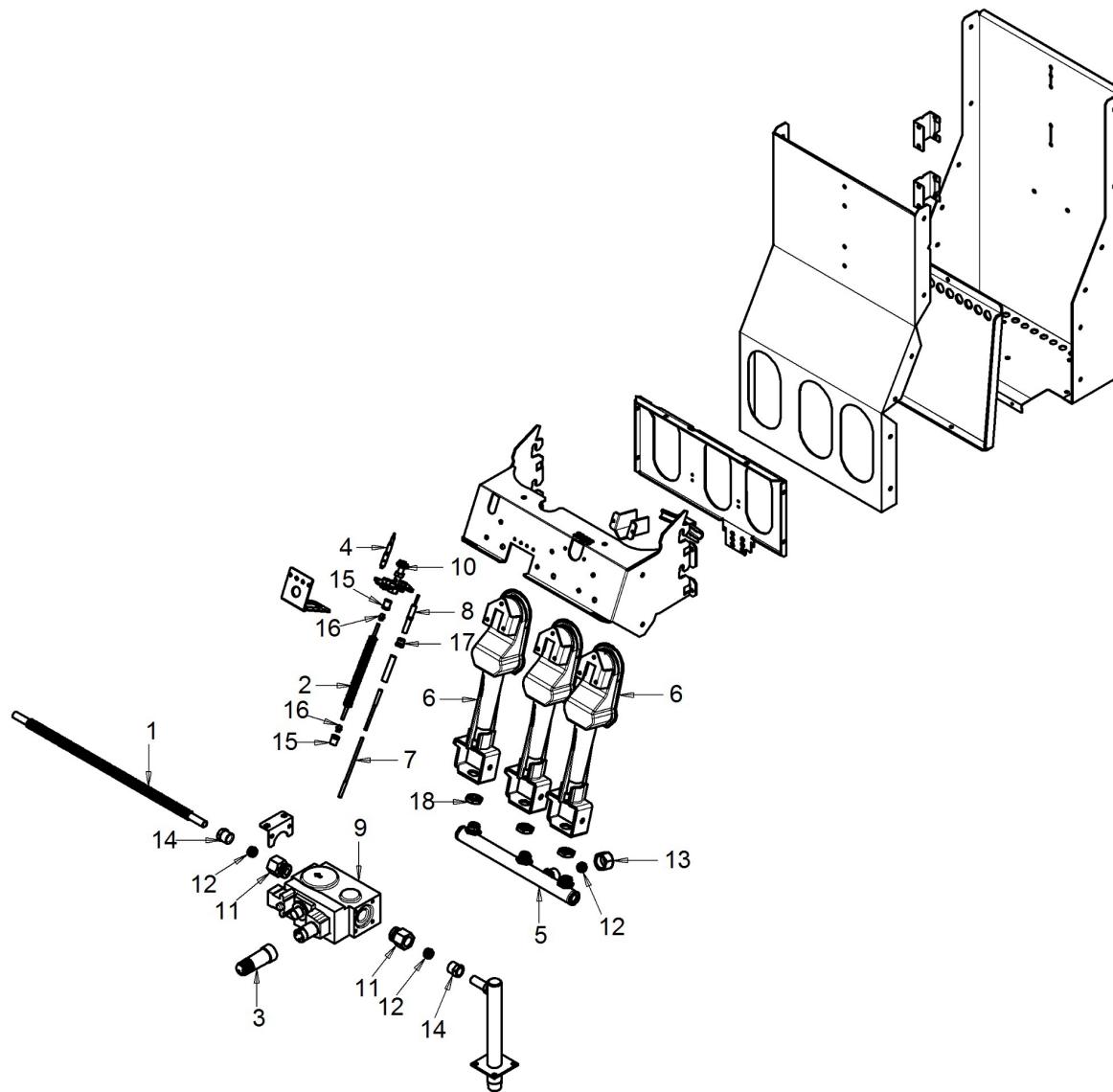







1
HOME / COTTURA / ICON7000 / OS1FR3GD / K010350 - M.COMBUSTIONE / 1



1
HOME / COTTURA / ICON7000 / OS1FR3GD / K010350 - M.COMBUSTIONE / 1

	Modifica	 ↑↓	Codice	↑↓ Descrizione	↑↓ Cons.	Prezzo ↑↓	Qtà Data validità
		1	3014320	TUBO PIEGHEVOLE DN10 L=400		0,00	1 06/04/2021-29/09/2022
		1	3014321	TUBO PIEGHEVOLE DN10 L=400	X	45,48	1 30/09/2022-31/07/2023
		1	3066040	TUBO PIEGHEVOLE DN12 L=400	X	48,36	1 01/08/2023-04/09/2023
		1	3066050	TUBO PIEGHEVOLE DN12 L=600	X	57,50	1 05/09/2023-
		2	3079320	TUBO SPIA PILOTA FLESSIBILE L=750	X	49,26	1 06/04/2021-
		3	3227400	PROLUNGA MANOP. L=65	X	10,18	1 06/04/2021-
		4	3363710	TERMOCOP. DEVIATA M9X1X1000	X	54,74	1 06/04/2021-
		5	3421310	COLLETTORE COMP.3POS.		84,71	1 06/04/2021-
		6	3421470	BRUCIATORE 5,5 KW	X	300,89	3 06/04/2021-
		7	32A2361	CAVO "HF" 1200MM	X	12,80	1 06/04/2021-
		8	32T0190	CANDELETTA ACCENSIONE	X	11,01	1 06/04/2021-
		9	33A0460	VALVOLA NOVASIT 820 1/2"-50Hz-230/240V	X	302,41	1 06/04/2021-
		10	33A2010	CORPO SPIA PILOTA		37,52	1 06/04/2021-
		11	33Q2571	RIDUZIONE MF 3/8"-1/2"	X	13,67	2 06/04/2021-
		12	36Q0030	BICONO Ø12X8	X	2,58	3 06/04/2021-
		13	36Q0050	SERRABICONO Ø 12	X	7,35	1 06/04/2021-
		14	36Q0710	SERRABICONO M Ø 12	X	7,97	2 06/04/2021-
		15	36Q1000	DADO SERRABICONO §4	X	2,35	2 06/04/2021-
		16	36Q1040	BICONO §4	X	2,63	2 06/04/2021-
		17	36Q1050	RAC. CANDELA ACCENS.	X	2,26	1 06/04/2021-

¹
[HOME](#) / [COTTURA](#) / [ICON7000](#) / [0S1FR3GD](#) / [K010350](#) - M.COMBUSTIONE / 1

	Modifica	   Codice	  Descrizione	  Cons.	Prezzo  	Qtà Data validità
		18 36Q1110	C/DADO 3/8"	X	5,24	306/04/2021-